



Product Information

Interactive PDF

INTERNET-LINK 

VIDEO/ANIMATION 

Release 1.0

## **Axio Zoom.V16**

The Fluorescence Zoom Microscope for Large Fields



We make it visible.

## Axio Zoom.V16

The Fluorescence Zoom  
Microscope for Large Fields

- › **In Brief**
- › The Advantages
- › The Applications
- › The System
- › Technology and Details
- › Service

# It's About Brilliance. Because Only the Best Is Good Enough

In 1994, the molecular biologist Douglas Prasher discovered that GFP was suitable as a marker for proteins. At the time, hardly anybody suspected what this would mean for the development of the stereo microscope: 'stereo magnifiers' experienced a renaissance. Scientists were now able to view complete model organisms in fluorescence contrast. Alongside the enthusiasm for these devices, the performance of stereo and zoom microscopes has also grown noticeably, with systems from Carl Zeiss keeping the bar high.

As we say: they are simpler, more intelligent, more integrated. They also give your work the brilliance it deserves.



# Axio Zoom.V16: Simpler. More Intelligent. More Integrated.

## Axio Zoom.V16

The Fluorescence Zoom  
Microscope for Large Fields

- › In Brief
- › **The Advantages**
- › The Applications
- › The System
- › Technology and Details
- › Service

## Bright Fluorescence in Large Fields

For the first time, Axio Zoom.V16 combines a 16x zoom with a high numerical aperture of NA 0.25, moving to the forefront of all known stereo and zoom microscopes. It achieves a very high aperture in the medium zoom range already: you get superior fluorescence brightness in large object fields. With Plan-NEOFLUAR Z 2.3x you can achieve a numerical aperture of NA 0.5 in an object field of 1.5 millimeters. Use ApoTome.2 for fluorescence imaging to obtain optical sections. You get a system that masters routine screening as well as your most demanding multidimensional imaging applications – Axio Zoom.V16 does it all brilliantly.

## Optimized Zoom for a Variety of Applications

The eZoom of Axio Zoom.V16 works with a motorized iris diaphragm coupled to the zoom. Simply select the best mode for your purpose by pressing a button on the SYCOP 3.

*Brightness mode:* Observe fluorescence images over the complete zoom range with highest possible brightness.

*Eyepiece mode:* This is ideal if you work mainly with ocular observation using conventional illumination. You can zoom from large object fields with maximum depth of field to high magnifications with maximum resolution.

*Camera mode:* The optics of your Axio Zoom.V16 adapt to the performance of your camera. You get an optimal relation between resolution and depth of field across the whole zoom range.

## Intelligent Transmitted Light Over the Whole Zoom Range

In addition to brightfield, darkfield and oblique illumination, you can get an increased contrast brightfield at the touch of a button. With the Best Mode button, Axio Zoom.V16 determines the actual optical state and optimizes transmitted light automatically. Use the Adjust control to fine-tune Best Mode more precisely to your application. Then simply save your setting and reload it for your next experiment - once again, at the touch of a button.



# Your Insight Into the Technology Behind it

## Axio Zoom.V16

The Fluorescence Zoom Microscope for Large Fields

- > In Brief
- > **The Advantages**
- > The Applications
- > The System
- > Technology and Details
- > Service

### At the Limits: Conventional Zoom Technology

The zoom body is the core of stereo and zoom microscopes. When zooming, lenses have to be positioned precisely. Until now, a metal component milled with great care would determine the exactness of this movement, and with it the optical quality of your microscope.

### Now eZoom Images Are Twice as Sharp

With Axio Zoom.V16, eZoom replaces the mechanical curve with an electronic one. Stepping motors position the moveable lenses precisely and take the tolerances of the individual lenses into account. Each zoom body describes its own zoom curve and captures visibly more details.

eZoom follows the base line for image sharpness over the magnification range with a doubled precision, compared to a mechanical zoom body. Zoom curves can be programmed individually.

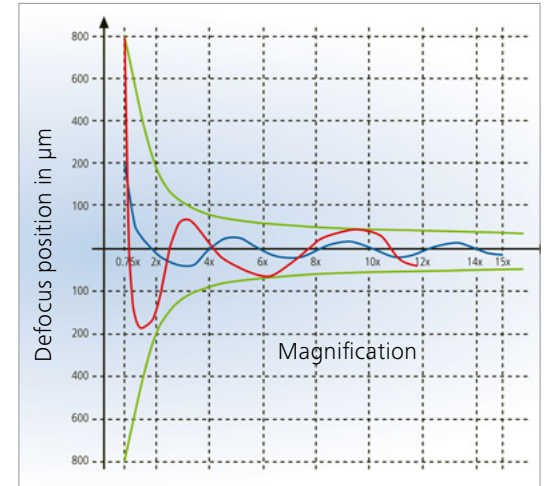

- depth of field curve, within these parameters images are in focus
- typical defocus curve of a single zoom channel with mechanical zoom curve
- typical defocus curve of a single zoom channel with electronic zoom curve



When the micro clapper of the computer-controlled glue leveling machine brings eZoom's lens in the zoom body into position ...

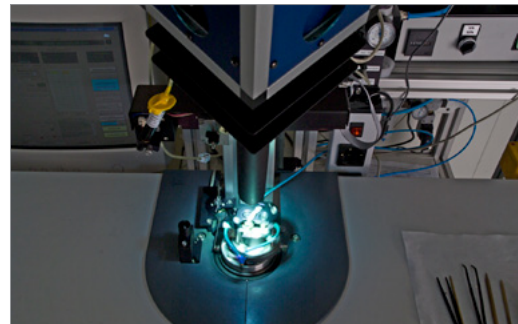

... it is glued and cured with UV light.



From around 7,000 reference points, the zoom body adjustment device calculates the zoom control curve.

# Tailored Precisely to Your Applications

## Axio Zoom.V16

The Fluorescence Zoom  
Microscope for Large Fields

- › In Brief
- › The Advantages
- › **The Applications**
- › The System
- › Technology and Details
- › Service

### Typical applications, typical specimens

Plant biology	Developmental biology	Forensics
<b>Task</b>		
Observe whole living plants	Screen a large number of whole model organisms, e.g. embryos of Zebrafish and Drosophila, Identify promising specimens, Image with high fluorescence intensity	Find minute human traces on large objects

### Axio Zoom.V16 provides

Axio Zoom.V16	Fully motorized Axio Zoom.V16	Fully motorized Axio Zoom.V16
Plan-NEOFLUAR Z 1x	SYCOP 3	SYCOP 3
HXP 200 C	Plan-NEOFLUAR Z 2.3x	Plan-NEOFLUAR Z 1x
Filterset FS 38 HE	HXP 200 C Filterset FS 38 HE, FS 43 HE	HXP 200 C Filterset FS 27 3D - micromanipulator „aureka“ ( <a href="http://www.auraoptik.de">www.auraoptik.de</a> )

### Example

Identify and document weakly autofluorescent gland tissue of Nepenthes, Isolate glands of interest

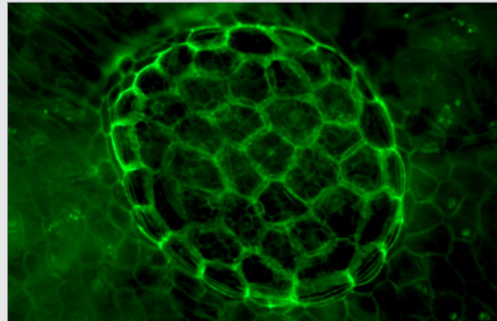

Sort and evaluate Drosophila embryos, Acquire multidimensional images

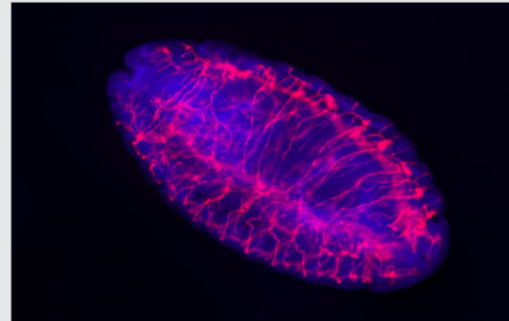

Identify human cells, Isolate and transport them to the PCR tube

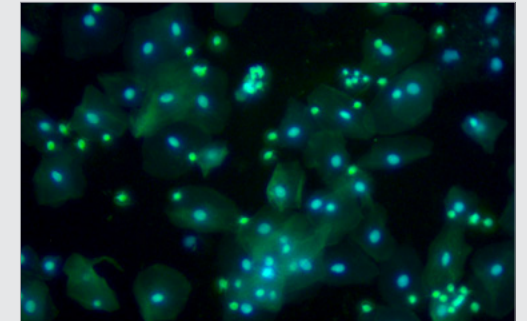

# Your Insight into the Technology Behind It

## Axio Zoom.V16

The Fluorescence Zoom  
Microscope for Large Fields

- > In Brief
- > The Advantages
- > The Applications
- > **The System**
- > Technology and Details
- > Service



### ApoTome.2 – Create Optical Sections of Your Fluorescent Samples

With structured illumination, you know that only the focal plane appears in your image: ApoTome.2 recognizes the magnification and moves the appropriate grid into the beampath. The system then calculates your optical section from three images with different grid positions. It's a totally reliable way to prevent scattered out-of-focus light, even in your thicker specimens. You get images with high contrast in the best possible resolution – simply brilliant optical sections.



Animation from [www.zeiss.com/campus](http://www.zeiss.com/campus), © Mike Davidson, FSU, Tallahassee

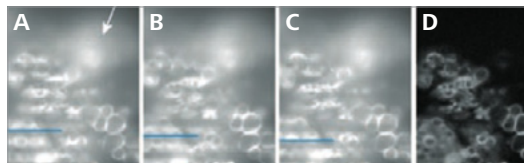

Schematic illustration of the grid projection.  
A-C: raw images with different positions of grid  
D: optical section through sample

### ApoTome.2 Grid in the Beampath

Fluorescence excitation light passes through two glass plates in the ApoTome.2 slider. When a grid structure is applied to the first glass plate, the grid pattern is “imprinted” in the excitation light. A scanning mechanism tilts the second glass plate and the image of the grid is laterally shifted in the focal plane of the specimen.

[www.zeiss.com/campus](http://www.zeiss.com/campus)

# Axio Zoom.V16: A Flexible Choice of Components

## Axio Zoom.V16

The Fluorescence Zoom  
Microscope for Large Fields

› In Brief

› The Advantages

› The Applications

› **The System**

› Technology and Details

› Service

## Axio Zoom.V16 for fluorescence screening

### 1 Microscope

- Axio Zoom.V16 microscope body
- Binocular ergo phototube Z 0-30° mot with PL 16x/16 eyepieces
- Stand base 450
- Focus motor 3 with profile column
- Objective nosepiece Z, 2x cod
- Mechanical stage S 150x100 mot; CAN
- System Operator Panel SYCOP 3 with Controller EMS 3
- **Option:** ApoTome.2 module

### 2 Objectives

- Plan-NEOFLUAR Z 1.0x/0.25 FWD 56mm
- Plan-NEOFLUAR Z 2.3x/0.57 FWD 10.6mm

### 3 Illumination

- Fluor Illuminator Z mot
- Reflector modules Z FL P&C (ACR or ACR RW)
- HXP 200 C (metal halide)
- Transillumination top 450 mot (brightfield, brightfield+, darkfield, oblique illumination)

### 4 Cameras

- AxioCam HRm
- AxioCam MRm



### 5 Software

Recommended ZEN modules:

- Multi Channel, Z Stack, Time Lapse (imaging)
- Tiles & Positions (imaging with scanning stage)

# Axio Zoom.V16: A Flexible Choice of Components

## Axio Zoom.V16

The Fluorescence Zoom  
Microscope for Large Fields

- › In Brief
- › The Advantages
- › The Applications
- › **The System**
- › Technology and Details
- › Service

## Axio Zoom.V16 for fluorescence imaging

### 1 Microscope

- Axio Zoom.V16 microscope body
- Binocular phototube Z 15°  
with PL 10x/23 eyepieces
- Transmitted light base 300
- Coarse/fine drive with profile column 490mm
- Mount S with diameter 76mm

### 2 Objective

- Objective Plan-NEOFLUAR Z 1.0x/0.25 FWD  
56mm

### 3 Illumination

- Fluar Illuminator Z mot
- Reflector modules Z FL P&C
- HXP 200 C (metal halide)
- Brightfield, darkfield, oblique transmitted light





# Axio Zoom.V16: System Overview

## Axio Zoom.V16

The Fluorescence Zoom  
Microscope for Large Fields

- > In Brief
- > The Advantages
- > The Applications
- > The System
- > Technology and Details
- > Service

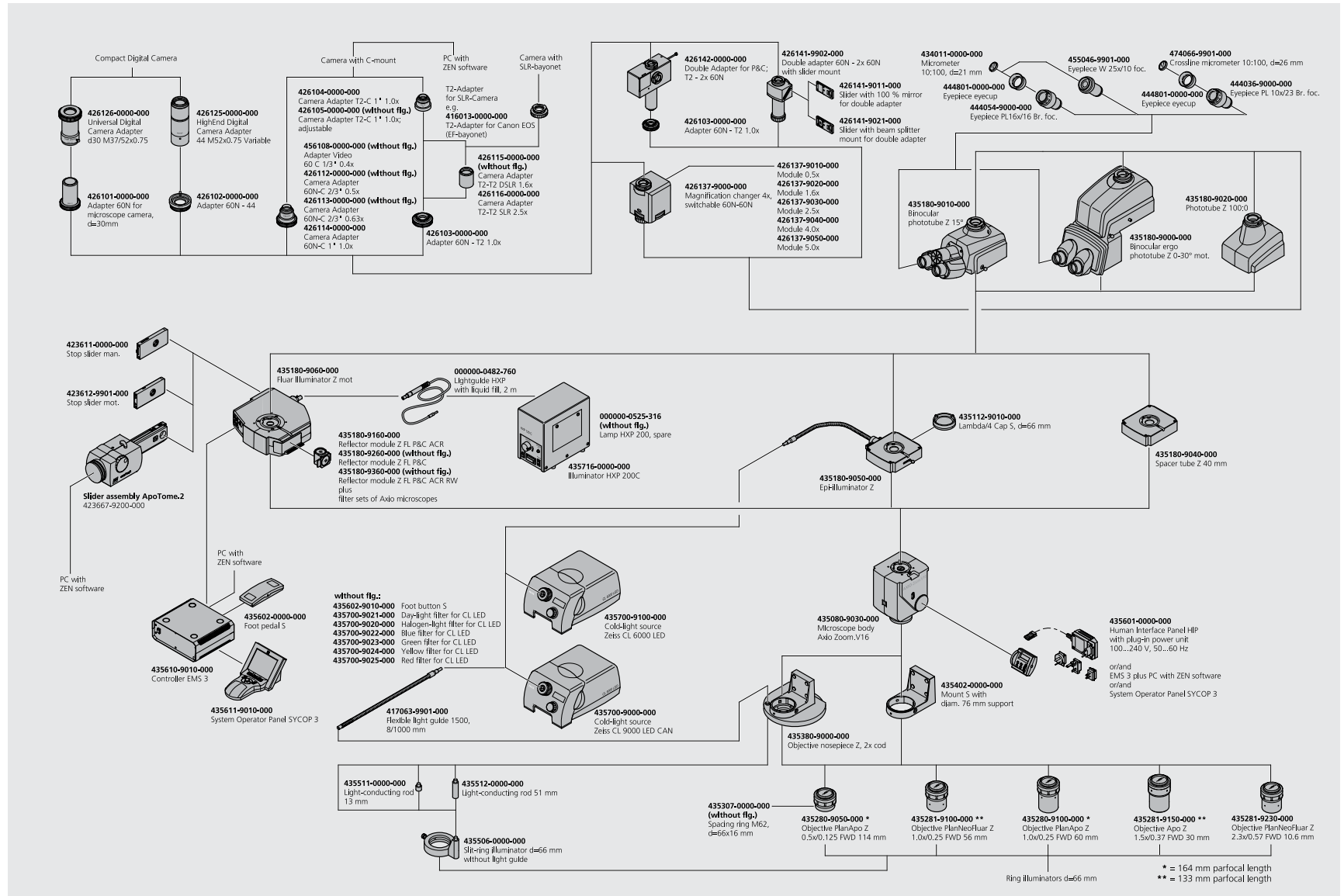

# Axio Zoom.V16: System Overview

## Axio Zoom.V16

The Fluorescence Zoom  
Microscope for Large Fields

- › In Brief
- › The Advantages
- › The Applications
- › The System
- › Technology and Details
- › Service

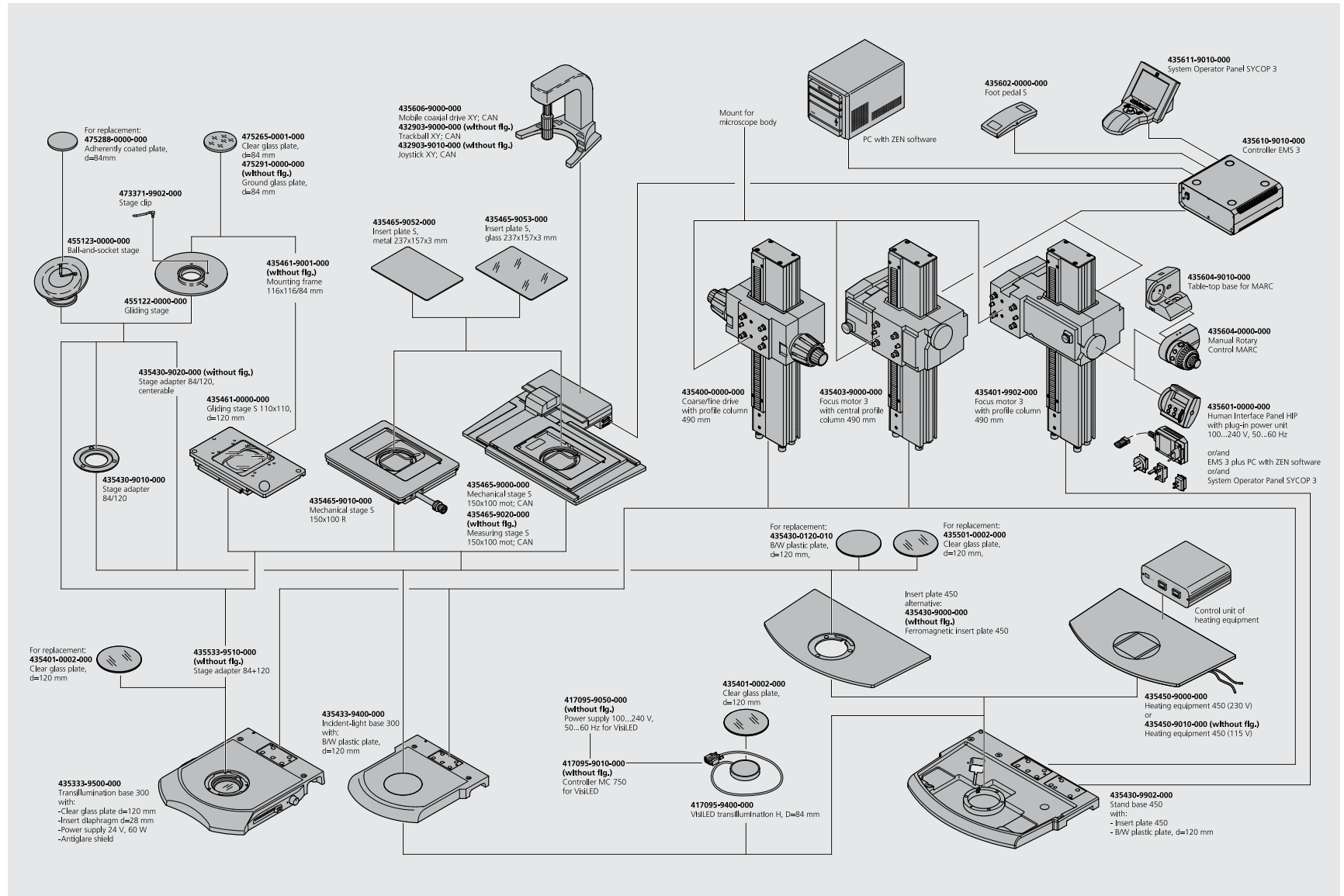

# Axio Zoom.V16: System Overview

## Axio Zoom.V16

The Fluorescence Zoom  
Microscope for Large Fields

- › In Brief
- › The Advantages
- › The Applications
- › The System
- › Technology and Details
- › Service

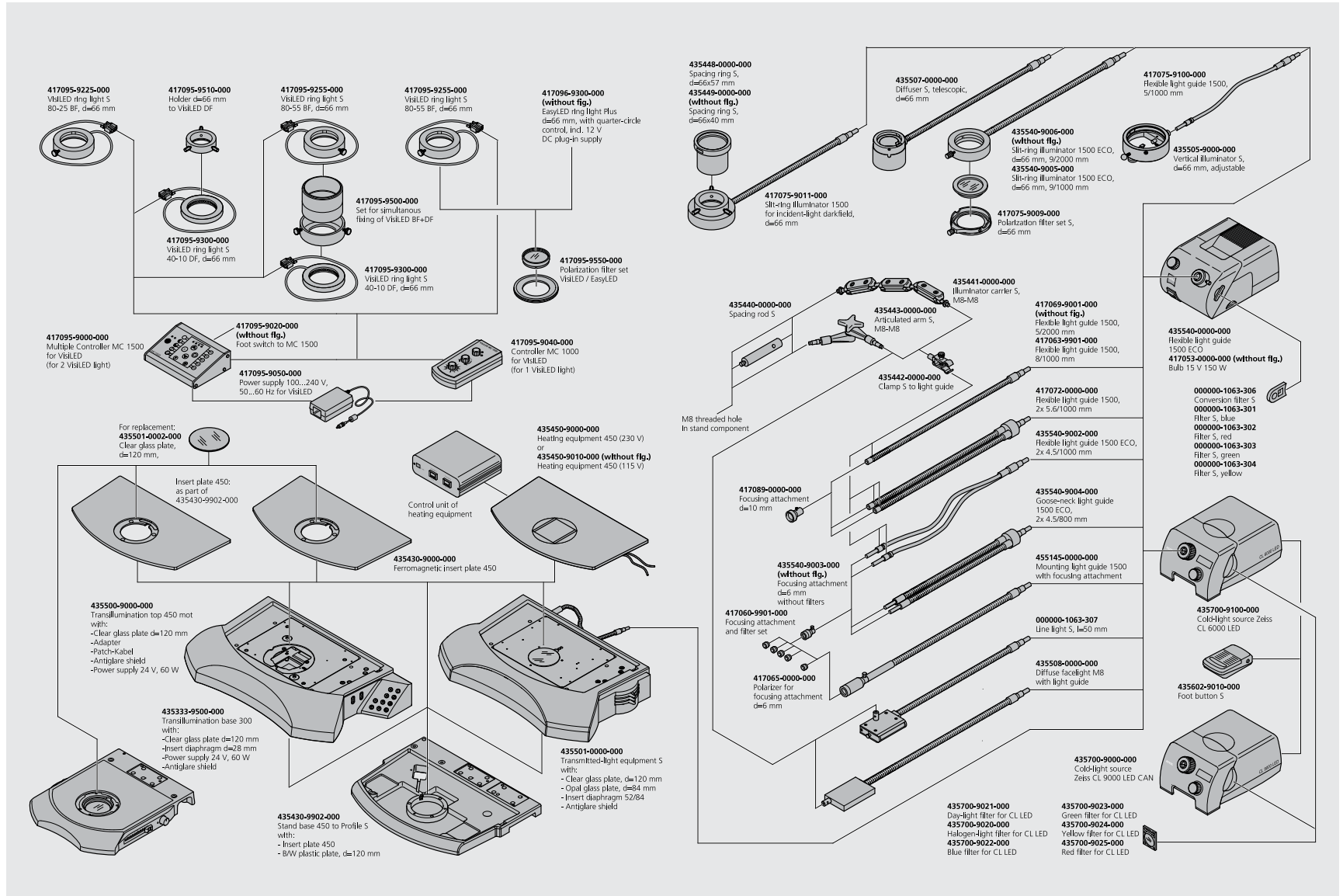

# Technical Specifications

## Axio Zoom.V16

The Fluorescence Zoom Microscope for Large Fields

- › In Brief
- › The Advantages
- › The Applications
- › The System
- › **Technology and Details**
- › Service

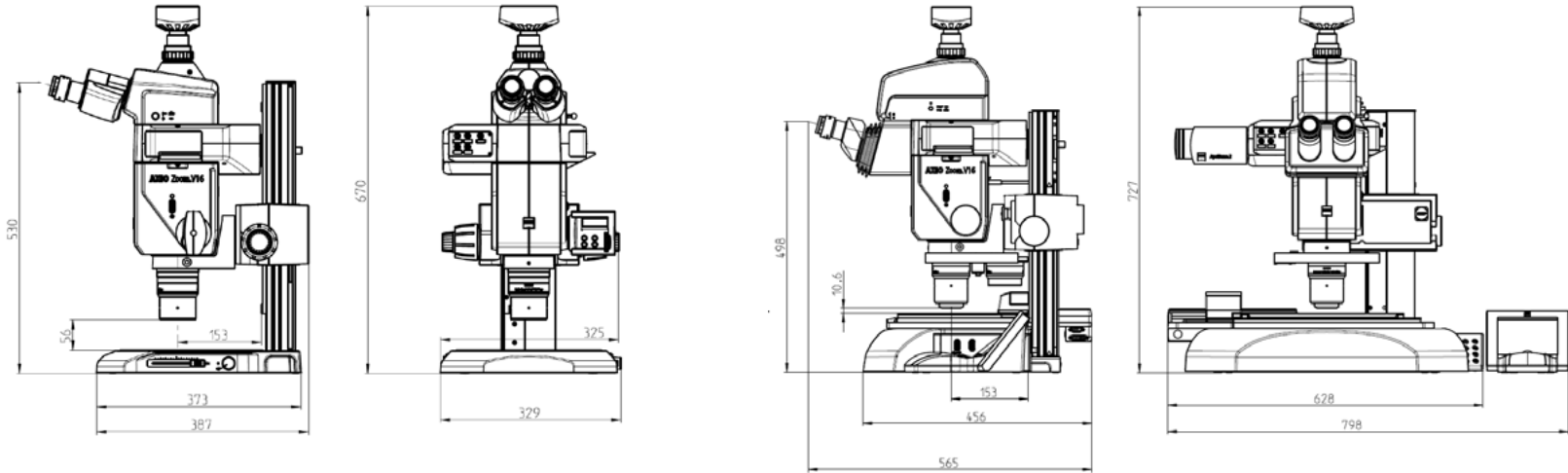

Objective	FWD (mm)	Eyepiece PL 10x/23 Magnification Object field (mm)	Eyepiece PL 16x/16 Magnification Object field (mm)
<b>PlanApo Z 0.5x</b> Parfocal length 164 mm	114	3.5x ... 56x 66 ... 4.1	5.6x ... 90x 46 ... 2.9
<b>PlanApo Z 1.0x</b> Parfocal length 164 mm	60	7x ... 112x 33 ... 2.0	11x ... 179x 23 ... 1.4
<b>Apo Z 1.5x</b> Parfocal length 133 mm	30	10.5x ... 168x 22 ... 1.4x	16.8x ... 269x 15.2 ... 0.95
<b>PlanNEOFLUAR Z 1.0x</b> Parfocal length 133 mm	56	7x ... 112x 33 ... 2.0	11x ... 179x 23 ... 1.4

# Count on Service in the True Sense of the Word

## Axio Zoom.V16

The Fluorescence Zoom  
Microscope for Large Fields

- › In Brief
- › The Advantages
- › The Applications
- › The System
- › Technology and Details
- › **Service**

Your results really matter to us: we want you to get the best you expect from your microscope. Depend on Carl Zeiss for everything you need: technology, software, advice and service. We stay with you long after installation of your microscope on site. ZEISS specialists will continue to maintain your systems, repair them, supply spare parts and much more. Just call us: we are always here for you.

### Total Protection with Your Carl Zeiss Service Contract

It's the safe and practical way to preserve the efficiency of your microscope system. Our service contract protects you against expensive downtime.

### Preventive Maintenance Plus Optimizes Performance

Our specialists will maintain and tune your system at regular intervals. You get valuable advice and comprehensive answers to any and all questions. We will also keep you right up to date on developments in your field of application.

### The Standard Contract Also Includes Repairs and Support

In addition to all the services of Preventive Maintenance Plus, the standard contract covers all repair and support services. The only costs you will ever pay are for replacement components. Another important aspect of the standard contract is installation of software updates – your system will always be running the latest program.

### The Premium Contract Covers Spare Parts Too

Opt for the premium contract and you will have all services of the standard contract, plus free spare parts. This means you can predict your running costs precisely – and budget for them.

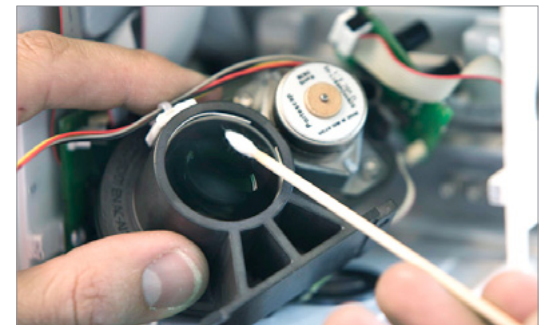

We are here for you:

[www.zeiss.com/microservice](http://www.zeiss.com/microservice)

## Axio Zoom.V16

The Fluorescence Zoom  
Microscope for Large Fields

- › In Brief
- › The Advantages
- › The Applications
- › The System
- › Technology and Details
- › Service

The moment technology provides  
you with a result the first time.

**This is the moment we work for.**



## Axio Zoom.V16

The Fluorescence Zoom  
Microscope for Large Fields

- › In Brief
- › The Advantages
- › The Applications
- › The System
- › Technology and Details
- › Service



[facebook.com/zeissmicroscopy](https://facebook.com/zeissmicroscopy)



[twitter.com/zeiss\\_micro](https://twitter.com/zeiss_micro)



[youtube.com/zeissmicroscopy](https://youtube.com/zeissmicroscopy)



### Carl Zeiss Microscopy GmbH

07745 Jena, Germany  
Biosciences  
[microscopy@zeiss.com](mailto:microscopy@zeiss.com)  
[www.zeiss.com/axiozoom](http://www.zeiss.com/axiozoom)



We make it visible.